

CREATING THE FIRST PROJECT IN **mikroBasic PRO for AVR**

 **MikroElektronika**

SOFTWARE AND HARDWARE SOLUTIONS FOR EMBEDDED WORLD ...making it simple

Project

The *mikroBasic PRO for AVR* organizes applications into projects consisting of a single project file (file with the **.mbpav** extension) and one or more source files (files with the **.mbas** extension). The *mikroBasic PRO for AVR IDE* allows you to manage several projects at a time. Source files can be compiled only if they are part of the project.

A project file contains:

- ▶ Project name and optional description;
- ▶ Target device in use;
- ▶ Device clock;
- ▶ List of the project source files;
- ▶ Binary files (***.mcl**);
- ▶ Image files; and
- ▶ Other files.

In this reference guide, we will create a new project, write code, compile it with the *mikroBasic PRO for AVR* and test the results. The purpose of this example is to make LED diodes on the microcontroller PORTA blink, which will be easy to test on AVR microcontrollers.

Hardware Connection

For the purpose of testing this example on an AVR microcontroller, it is necessary to connect hardware as per schematic below. LED diodes are connected to PORTA only. However, you can use any other port because this simple program will change the state of all ports in the same way.

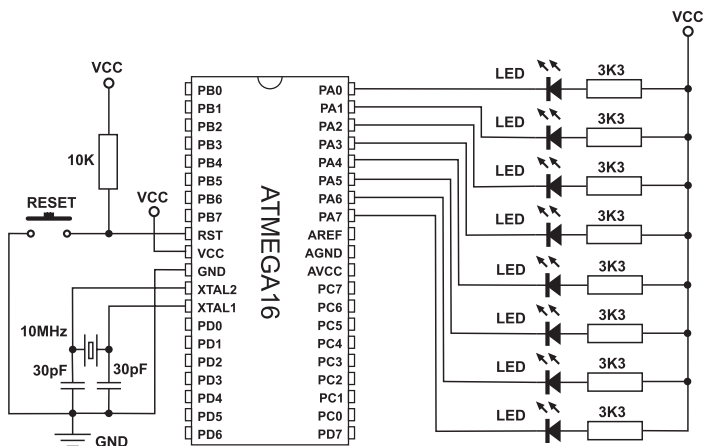

Prior to creating a new project, it is necessary to do the following:

Step 1: Install the compiler

Install the *mikroBasic PRO for AVR* compiler from the product CD:

CD:\zip\mikrobasic_pro_avr\mikrobasic_pro_avr_setup.exe

Desktop shortcut and start menu shortcut will be automatically created.

Step 2: Start up the compiler

Start up the *mikroBasic PRO for AVR* compiler by double clicking the appropriate icon. The *mikroBasic PRO for AVR IDE* (Integrated Development Environment) will appear on the screen.

After these two steps you are ready to create a new project.

New Project

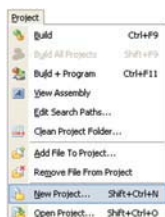

The process of creating a new project is very simple. Select the **New Project** option from the **Project** menu as shown in Figure on the left. The **New Project Wizard** window appears. It can also be opened by clicking the **New Project** icon from the **Project** toolbar.

Click here to start a new project



The **New Project Wizard** window will guide you through the process of creating a new project. The introductory window of this application contains a list of actions to be performed when creating a new project. Click **Next**.



Step 1:

From the **Device Name** drop-down list, select the microcontroller you want to write a program for.

Step 2:

Enter the oscillator frequency value in the **Device Clock** field.

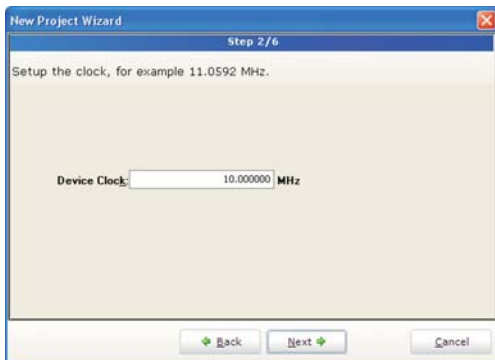
**Step 3:**

Specify the name and location of the project.

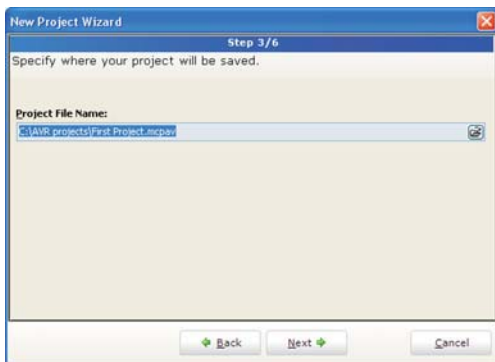
**Step 4:**

In the event that the project consists of several source files, it is necessary to specify them all and include into the project by clicking the **Add** button. It is also possible to add files later in the **Project Manager** window.

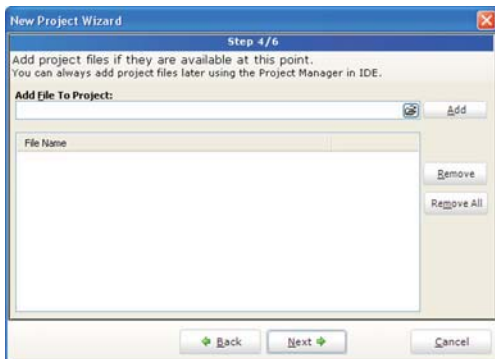

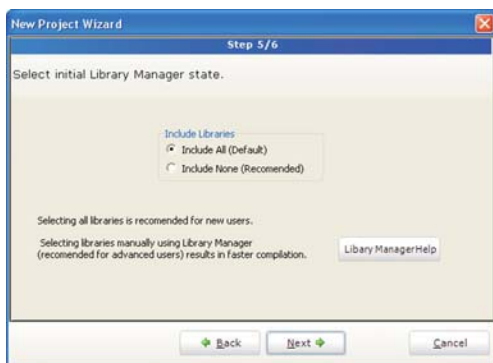
**Step 5:**

Choose between whether to include all libraries into the project or not.

**Step 6:**

After all, it is necessary to confirm all selected options by clicking **Finish**.



After creating the project, a new blank window to write a program in will appear. See Figure on the left. If you use *New Project Wizard* when creating a new project, a blank source file, named after the project with the *.mbas* extension, will automatically be created. The *mikroBasic PRO for AVR* does not require you to have a source file named the same as the project, it's just a matter of convenience.

This is the source code that is to make all microcontroller's I/O pins to change their logic state once per second. Any change of the microcontroller's port state can be seen on LEDs.

```
LedBlinking.mbas
*
*
* * Project name:
* *   LED_Blinking (Simple "Hello World" project)
* * Copyright:
* *   (c) Mikroelektronika, 2008.
* * Revision History:
* *   20080930:
* *     - initial release
* * Description:
10 *   This is a simple "Hello World" project. It turns on/off diodes connected to
* *   PORTA, PORTB, PORTC and PORTD.
* * Test configuration:
* *   MCU:           ATmega16
* *   Dev.Board:     EasyAVR5A
* *   Oscillator:    External Clock 08.0000 MHz
* *   Ext. Modules:  -
* *   SW:            mikroBasic for AVR PRO
* * NOTES:
* *   - Make sure you turn ON the PORT LEDs at SW6. (board specific)
20 *
*
program LED_Blinking
main:
  DDRA = 0xFF          ' set direction to be output

  while TRUE
    PORTA = 0x00       ' Turn ON diodes on PORTA
    Delay_ms(1000)    ' 1 second delay

    PORTA = 0xFF       ' Turn OFF diodes on PORTA
    Delay_ms(1000)    ' 1 second delay
  wend
33 end.
```

Compilation

When the program is written, it is necessary to compile it into a program (.hex) code, by selecting one of the build options from the **Project** menu:

- ▶ To create a HEX file, select **Build** (Ctrl+F9) from the **Project** menu or click the **Build** icon from the **Project** toolbar.
- ▶ The **Build All Projects** (Shift+F9) option builds all files within the project, libraries (if there is a source code for them) and **def** files for the chip in use.
- ▶ The **Build + Program** (Ctrl+F11) option is special as it enables the *mikroBasic PRO for AVR* compiler to automatically load the program into the microcontroller after compilation. The process of programming is performed by using the *AVRflash* programmer.

All the errors detected during compilation will be shown in the **Messages** window. If no errors are encountered, the *mikroBasic PRO for AVR* compiler will generate output files.

Output Files

The *mikroBasic PRO for AVR* compiler generates output files in the project folder containing the project file. Output files are summarized in the table below:

Format	Description	File Type
Intel HEX	Intel hex style records. It is used for programming AVR microcontrollers.	.hex
Binary	Compiled Library which may be included in other projects.	.mcl
Assembler File	Assembly file with symbolic names.	.asm
List File	Overview of AVR memory allotment. The List File represents an extended version of assembly code, i.e. contains addresses of instructions, registers, routines and labels.	.lst

Assembly Code Overview

After compilation, click the **View Assembly** icon or select the **View Assembly** option from the **Project** menu to review the generated assembly code in a new window. To overview the complete *List File*, select the **View Listing** option from the same menu.

Project Settings

Edit Project

By selecting the **Project Settings** option from the **View** menu, a new window providing possibility to change type and clock frequency of the microcontroller, appears. Any change in this window affects only the currently active project. If more than one project is open, make sure that the right project is set as active one in the **Project Manager**.

Project Group

As mentioned before, the *mikroBasic PRO for AVR IDE* enables several projects to be opened simultaneously. If there are several projects related to each other in some way, it is possible to create a project group.

The project group may be saved by clicking the **Save Project Group** icon in the **Project Manager** window. It may also be reopened by clicking the **Open Project Group** icon in the same window. All relevant data about the project group is stored in the project group file (file with the **.mbavgroup** extension).

Add/Remove Files from Project

A project may contain the following types of files:

- ▶ **.mbas** additional source files;
- ▶ **.mcl** binary files;
- ▶ **.pld** project level defines files;
- ▶ image files;
- ▶ **.hex**, **.asm** and **.lst** files. These files cannot be added or removed from the project; and
- ▶ other files.

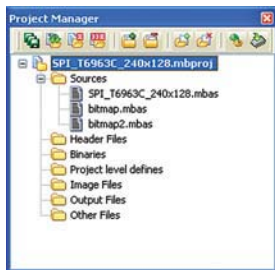

To add a file to the project, click the **Add File to Project** option from the **Project** menu or click the **Add File to Project** icon from the **Project** toolbar. Each added file must be self-contained, i.e. must have all definitions after preprocessing.

To remove file(s) from the project, click the **Remove File from Project** option from the **Project** menu or click the **Remove File from Project** icon from the **Project** toolbar.

Source Files

Creating a new source file

In order to create a new source file, it is necessary to select the **New Unit** option from the **File** menu, or press CTRL+N or click the **New File** icon from the **File** toolbar. A new window, i.e. a new source file automatically appears. Select the **Save** option from the **File** menu, or press CTRL+S or click the **Save File** icon from the **File** toolbar and name it as you want.

Opening an existing file

In order to open a saved file, it is necessary to select the **Open** option from the **File** menu, or press CTRL+O or click the **Open File** icon from the **File** toolbar. In the **Open** dialog box, browse the location of the file that you want to open, select it and click the **Open** button. The file will be automatically displayed in its own window. If such file is already open, it becomes active.

Printing an active file

First of all, it is necessary to make sure that the file you want to print is active. Select the **Print** option from the **File** menu or press CTRL+P and click the **OK** button. In the **Print Preview** window, set a desired layout of the document and click the **Print** icon.

Saving file

Make sure that the file you want to save is active.

In order to save it, it is necessary to select the **Save** option from the **File** menu, or press Ctrl+S, or click the **Save File** icon from the **File** toolbar.

Saving file under different name

Make sure that the file you want to save is active.

In order to save it under different name, it is necessary to select the **Save As** option from the **File** menu. The **Save As** dialog box will appear. Here you can browse the folder in which you want to save the file. In the **File Name** field, modify the name of the file you want to save and click the **Save** button.

Closing file

Make sure that the file you want to close is active.

In order to close it, it is necessary to select the **Close** option from the **File** menu, or right click the window of the file you want to close and select the **Close** option. If the file has been changed since it was last saved, you will be prompted to save the changes.

Clean Project Folder

The **Clean Project Folder** option from the **Project** menu gives you a possibility to choose the files that you want to delete from your current project.

Select the files you want to delete from the project and click the **Clean** button. The selected files will be permanently deleted. Please note that only files in bold are generated by the compiler and can be recreated after the process of compilation.





If you want to learn more about our products, please visit our website: www.mikroe.com

If you are experiencing some problems with any of our products or just need additional information, please place your ticket at: www.mikroe.com/en/support

If you have any question, comment or business proposal, do not hesitate to contact us: office@mikroe.com